

European standard

French standard

NF EN 14682
February 2008

Classification index: **G 30-105**

ICS: 61.020

Safety of children's clothing

Cords and drawstrings on children's clothing

Specifications

- F : Sécurité des vêtements d'enfants — Cordons et cordons coulissants sur les vêtements d'enfants — Spécifications
D : Sicherheit von Kinderbekleidung — Kordeln und Zugbänder an Kinderbekleidung — Anforderungen

French standard approved

by decision of the Director General of AFNOR on January 29, 2008 taking effect on February 29, 2008.

Replaces the approved standard NF EN 14682, dated March 2005.

Correspondence

The European standard EN 14682:2007 has the status of French standard.

Analysis

This document specifies requirements for cords, drawstring or otherwise, on children's clothing, including disguise costumes and skiwear, up to the age of 14 years.

Within the scope of this document it is not possible to cover all potential hazards that an unsafe garment may create.

Descriptors

Technical International Thesaurus: clothing, garments, children, ropes, end pieces, touch and close fasteners, specifications, safety, accident prevention.

Modifications

With respect to document replaced, revision of the standard.

Corrections



EUROPEAN STANDARD

EN 14682

NORME EUROPÉENNE

EUROPÄISCHE NORM

December 2007

ICS 61.020; 97.190

Supersedes EN 14682:2004

English Version

Safety of children's clothing - Cords and drawstrings on children's clothing - Specifications

Sécurité des vêtements d'enfants - Cordons et cordons coulissants sur les vêtements d'enfants - Spécifications

Sicherheit von Kinderbekleidung - Kordeln und Zugbänder an Kinderbekleidung - Anforderungen

This European Standard was approved by CEN on 21 October 2007.

CEN members are bound to comply with the CEN/CENELEC Internal Regulations which stipulate the conditions for giving this European Standard the status of a national standard without any alteration. Up-to-date lists and bibliographical references concerning such national standards may be obtained on application to the CEN Management Centre or to any CEN member.

This European Standard exists in three official versions (English, French, German). A version in any other language made by translation under the responsibility of a CEN member into its own language and notified to the CEN Management Centre has the same status as the official versions.

CEN members are the national standards bodies of Austria, Belgium, Bulgaria, Cyprus, Czech Republic, Denmark, Estonia, Finland, France, Germany, Greece, Hungary, Iceland, Ireland, Italy, Latvia, Lithuania, Luxembourg, Malta, Netherlands, Norway, Poland, Portugal, Romania, Slovakia, Slovenia, Spain, Sweden, Switzerland and United Kingdom.



EUROPEAN COMMITTEE FOR STANDARDIZATION
COMITÉ EUROPÉEN DE NORMALISATION
EUROPÄISCHES KOMITEE FÜR NORMUNG

Management Centre: rue de Stassart, 36 B-1050 Brussels

EN 14682:2007 (E)

Contents

	Page
Foreword	3
Introduction	4
1 Scope	5
2 Terms and definitions	5
3 Requirements	9
Annex A (informative) Background	12
Annex B (informative) Anthropometric data	13
Annex C (informative) Rationale	15
Annex D (normative) Measurement of cord length	16
Annex E (informative) Considerations for risk assessments	18
Annex F (informative) Examples of cords and drawstrings	19
Bibliography	29

Foreword

This document (EN 14682:2007) has been prepared by Technical Committee CEN/TC 248 "Textiles and textile products", the secretariat of which is held by BSI.

This European Standard shall be given the status of a national standard, either by publication of an identical text or by endorsement, at the latest by June 2008, and conflicting national standards shall be withdrawn at the latest by June 2008.

This document supersedes EN 14682:2004.

The main difference between this revision and the 2004 edition is that figures have been added to assist in clarification of the text.

This document has been prepared under a mandate given to CEN by the European Commission and the European Free Trade Association.

According to the CEN/CENELEC Internal Regulations, the national standards organizations of the following countries are bound to implement this European Standard: Austria, Belgium, Bulgaria, Cyprus, Czech Republic, Denmark, Estonia, Finland, France, Germany, Greece, Hungary, Iceland, Ireland, Italy, Latvia, Lithuania, Luxembourg, Malta, Netherlands, Norway, Poland, Portugal, Romania, Slovakia, Slovenia, Spain, Sweden, Switzerland and United Kingdom.

EN 14682:2007 (E)

Introduction

The European Commission Mandate No. M/309 The Safety of Consumers: drawstrings or cords on children's clothing, issued 9 March 2001 requested that CEN develop standards or specifications to consider cords and drawstrings on clothing intended for children up to age 14 years.

The aim of this European Standard is to minimise the risk of accidental entrapment by cords or drawstrings on children's clothing taking into account:

- a) the child's age;
- b) normal behaviour and activities of children for their age and stage of development, for example playing in playgrounds, climbing trees, travelling by bus or train, ability to look after themselves, and where relevant, level of supervision;
- c) national accident statistics indicate that serious accidents involving cords and drawstrings on children's clothing fall into two main groups by age of child;
 - 1) younger children: entrapment of hood cords in playground equipment such as slides, resulting in fatalities;
 - 2) older children and young persons: entrapment of cords and strings from the waist and lower hems of garments in moving vehicles such as bus doors, ski lifts and bicycles resulting in severe injuries or death from being dragged along or run over by the vehicle.

In addition elasticated hood or neck cords have resulted in a number of facial injuries.

Children's clothing sold in the EU is usually sold by height as the primary measurement, sometimes with age as an additional indicator. Clothing for babies (up to around 1 year of age) is generally sold by length of the baby although some countries use the baby's weight. All chest, waist, and hip measurements are secondary measurements.

1 Scope

This European Standard specifies requirements for cords and drawstrings on children's clothing, including disguise costumes and skiwear, up to the age of 14 years.

Within the scope of this European Standard it is not possible to cover all potential hazards that may create an unsafe garment.

Conversely, identifiable specific hazards in certain styles/design of garment might not present a risk for certain age groups.

NOTE It is recommended that an individual risk assessment is carried out on any garment in order to ensure that it does not present a hazard to the wearer.

This European Standard does not apply to:

- a) child use and care articles for example bibs, nappies and soother holders;
- b) shoes, boots and similar footwear;
- c) gloves, hats, bonnets and scarves;
- d) neckties designed to be worn with a shirt or blouse;
- e) belts and braces;
- f) religious clothing that may be worn all the time, and celebratory clothing such as that worn at civil or religious ceremonies or regional or national festivals;
- g) specialist sportswear and activity wear generally worn for limited periods and under supervision, for example rugby shorts, wet suits, and dancewear, except where those garments are commonly worn as day wear or night wear;
- h) theatrical costumes used for theatrical performances;
- i) aprons intended to be worn over day wear, for limited periods and under supervision, to protect clothing from soiling during activities such as painting, cooking, or during meal times.

2 Terms and definitions

For the purposes of this document, the following terms and definitions apply.

2.1

young child

person aged from birth to age 7 years (that is 6 years and 11 months) which includes all children up to and including a height of 134 cm (see Annex B)

2.2

older child and young person

person aged from 7 years up to age 14 years (that is up to 13 years and 11 months) which includes all boys of height greater than 134 cm up to 182 cm and girls of height greater than 134 cm up to 176 cm (see Annex B)

2.3

children's clothing

all garments intended by design, production route or selling route to be worn by children up to the age of 14 years, including all garments intended for boys up to a height of 182 cm and for girls up to a height of 176 cm

EN 14682:2007 (E)**2.4****drawstring**

cord, chain, ribbon, string or tape of any textile or non-textile material with or without embellishment, such as a toggle, pom-pom, feather, or bead which passes through a channel, loop(s) or eyelet(s) or similar, to adjust the size of the opening, or part of the garment or to fasten the garment itself

NOTE 1 The protruding length of the drawstring may increase when closure is effected.

NOTE 2 For some garments a drawstring may be a loop with a tightening device rather than a single length with two ends that may or may not be tied.

2.5**functional cord**

cord, chain, ribbon, string or tape of any textile or non-textile material with or without embellishment, such as toggle, pom-pom, feather or bead, of fixed length, which is used to adjust the size of the opening, or part of the garment or to fasten the garment itself

2.6**decorative cord**

non-functional cord, chain, ribbon, string or tape of any textile or non-textile material with or without embellishment such as toggle, pom-pom, feather or bead, of fixed length which is not intended to be used to adjust the size of the garment opening or fasten the garment itself

2.7**elastic cord**

cord containing yarns of rubber or elastodiene or elastane polymer or similar, having high extensibility and complete or near complete recovery

2.8**shoulder strap**

functional cord joining the front and back of a garment top together, which is close fitting and passes over the shoulder

2.9**halter neck cord**

functional cord worn round the back of the neck holding the garment (for example dress, blouse or bikini) top leaving the shoulder and back bare

2.10**tied belt or sash**

drawstring, decorative or functional cord or piece of textile material of not less than 30 mm width tied round the waist area of a garment

2.11**stirrup**

narrow strip of textile or non-textile material attached to the lower hem of a trouser such that it passes under the foot or shoe to create a close fit to the wearer

2.12**toggle**

wooden, plastic, metal or otherwise composed piece attached to or present on, a drawstring, functional cord or decorative cord

NOTE Toggles may or may not be functional.

2.13**loop**

cord or narrow strip of fabric curved in shape, which may be fixed or adjustable in length, where both ends are attached to the garment

2.14

hood and neck area

part of the body from the top of the head to the top of the chest, level with the top of the armpits (axillae) and in between points on shoulder straight up from armpit (see Figure 1, zone A)

2.15

chest and waist area

part of the body from the top of the chest level with the armpits (axillae) to the hip level with the crotch (see Figure 1, zone B)

2.16

below hip area

part of the body below the hip, level with the crotch (see Figure 1, zone C)

2.17

back area

posterior part of the body and legs (see Figure 2, zone D)

EN 14682:2007 (E)

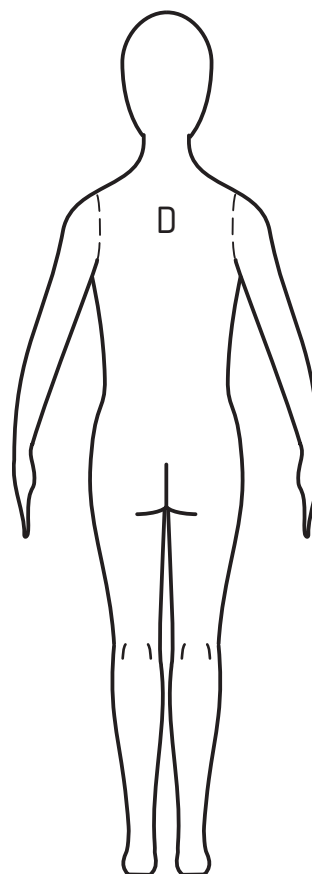
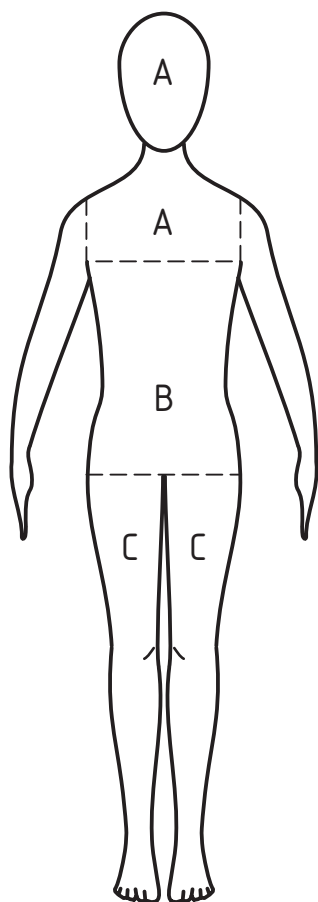

Key

- A hood and neck area
- B chest and waist area
- C below hip
- D back area

Figure 1 — Body zones – front

Figure 2 — Body zones – back

2.18

zip puller

fitting attached to the slider to facilitate manipulation

2.19

zip slider

moving component consisting essentially of a slider body and, normally, a puller, which opens or closes the fastener by separating or engaging the interlocking members

EN 14682:2007 (E)

NOTE The slider might incorporate a locking device. Alternative slider types are available with a flip-over puller or double pullers, to facilitate operation from both front and back sides.

2.20**adjusting tab**

small strip of fabric not less than 20 mm in width intended to adjust the size of opening on a garment for example at the ankle or sleeve cuff

3 Requirements**3.1 General**

3.1.1 The free ends of drawstrings, functional cords, and tied belts or sashes shall have no three-dimensional embellishments or knot and shall be secured to prevent fraying, for example by heat sealing or bar tacking. The ends may be doubled or folded provided no hazard of entrapment is created.

3.1.2 Toggles shall only be used on drawstrings with no free ends or decorative cords (see Figure F.1).

3.1.3 Where drawstrings are permitted, they shall be attached to the garment, for example using a bar tack, in at least one point positioned equidistant from the exit points (see Figure F.3).

3.1.4 Fixed loops, which protrude from the garment, for example to fasten, shall be no more than 75 mm in circumference. Flat loops which do not protrude from the garments, for example for belt loops, shall be no more than 75 mm in length, between the fixed points of attachment to the garment (see Figure F.4).

3.1.5 Zip pullers including any embellishment shall be no longer than 75 mm in length from zip slider and shall not hang below the lower edge of garments designed to finish at the ankle (see Figure F.5).

3.1.6 All measurements shall be carried out in accordance with Annex D.

3.2 Hood and neck area on garments for young children (Figure 1, zone A)

3.2.1 Garments intended for young children shall not be designed, manufactured or supplied with drawstrings, functional cords or decorative cords in the hood or neck area.

3.2.2 Adjusting tabs are permissible provided that the length is no more than 75 mm.

3.2.3 Shoulder straps are permissible provided they are constructed from one continuous length of material or cord attached at front and back of the garment. Decorative cords attached to a shoulder strap shall not have free ends longer than 75 mm and fixed loops shall be no more than 75 mm in circumference (see Figure F.7).

3.2.4 Halter neck-style garments shall be constructed with no free ends in the hood and neck area (see Figure F.8).

3.2.5 Stitched or otherwise attached embellishments, for example bows, shall not have free ends longer than 75 mm. Any loops shall be not greater than 75 mm in circumference (see Figure F.9).

3.3 Hood and neck area on garments for older children and young persons (Figure 1, zone A)

3.3.1 Drawstrings shall not have free ends.

When the garment opening is at its largest and the garment is laid flat there shall be no protruding loop. When the garment opening is at its smallest, i.e. the size it is intended to fit, maximum protruding loop circumference shall be 150 mm (see Figure F.10).

3.3.2 Functional cords and adjusting tabs shall be not more than 75 mm in length.

EN 14682:2007 (E)

Functional cords shall not be made from elastic cords, except for shoulder straps and halter necks.

3.3.3 Decorative cords shall not be more than 75 mm in length at either end including any attachment such as a toggle.

Decorative cords shall not be made from elastic cords.

3.3.4 Shoulder straps are permissible provided any free ends are no longer than 140 mm from the point at which they are to be tied and fixed loops are no more than 75 mm in circumference (see Figure F.7).

3.3.5 Halter neck-style garments shall be constructed with no loose ends in the hood and neck area (see Figure F.8).

3.4 Waist area of garments, internal and external to the garment (Figure 1, zone B)

3.4.1 Free ends of drawstrings in the waist area shall protrude by a maximum of 140 mm at each end when the garment is opened to its largest and laid flat, and by no more than 280 mm when closed to the intended size (see Figure F.15). Drawstrings with no free ends shall have a loop with a maximum circumference of 280 mm when closed to the intended size.

3.4.2 Functional cords, decorative cords and adjusting tabs in the waist area shall be a maximum of 140 mm including any embellishment on decorative cords.

3.4.3 For young children, tied belts or sashes intended to be tied at the back of the garment are permissible provided that when untied and measured from the point where they are to be tied, they shall be no more than 360 mm in length and, when untied, do not hang below the hem of the garment (see Figure F.16).

3.4.4 For older children and young persons, tied belts or sashes intended to be tied at the back of the garment are permissible provided that, when untied and measured from the point where they are to be tied they shall be no more than 360 mm in length (see Figure F.16).

3.4.5 For both age groups, tied belts or sashes intended to be tied at the front of the garment shall be acceptable provided that when untied they shall be no more than 360 mm in length measured from the point where they are to be tied (see Figure F.17).

3.5 Lower hems of garments which hang below the crotch (Figure 1, zone C)

3.5.1 Drawstrings, decorative cords or functional cords including any toggle on the lower edges of garments where the lower edge is situated below the crotch shall not hang below the lower edge of the garment (see Figure F.11).

3.5.2 Drawstrings or cords at the lower edges of garments shall lie flat against the garment, when the garment is tightened or fastened.

3.5.3 In garments that are designed to finish at the ankle (coats, trousers or skirts), the drawstrings, functional cords and decorative cords at the bottom hem shall be totally on the inside of the garment.

NOTE Stirrups at the hem of trousers are permissible.

3.5.4 Adjusting tabs are acceptable provided that they are no longer than 140 mm in length and shall not hang below the hem of the garment (see Figure F.12).

3.6 Back area (Figure 2, zone D)

3.6.1 Children's garments shall not be designed to have drawstrings, decorative cords or functional cords that emerge from the back of the garment or to be tied at the back (see Figure F.2).

3.6.2 Tied belts or sashes are permissible (see 3.4.3 and 3.4.4).

3.7 Sleeves

3.7.1 Drawstrings, functional cords and decorative cords at the lower edge of long sleeved garments shall be totally on the inside of the garment, when the garment is fastened (see Figure F.13).

3.7.2 For younger children, drawstrings, functional cords and decorative cords are permissible on short sleeved garments provided the sleeve finishes above the elbow and the maximum protruding length is 75 mm measured when the sleeve is open to its largest and laid flat (see Figure F.14).

3.7.3 For older children and young persons, drawstrings, functional cords and decorative cords are permissible on short sleeved garments provided the sleeve finishes above the elbow and the maximum protruding length is 140 mm measured when the sleeve is open to its largest and laid flat (see Figure F.14).

3.7.4 For both age groups, adjusting tabs are permissible on sleeves provided that they are no longer than 100 mm in length and when open shall not hang below the hem of the garment (see Figure F.6).

3.8 Other parts of the garment

In all other areas of the garment, not previously addressed, the drawstring or functional and decorative cords shall protrude by no more than 140 mm when the garment is open to its largest and laid flat.

EN 14682:2007 (E)

Annex A (informative)

Background

National accident statistics indicate accidents to children involving drawstrings, functional cords and decorative cords on children's clothing fall into two main groups.

Approximate age range 2 years to 8 years. Entrapment of hood or neck cords in playground equipment such as slides, resulting in strangulation.

Approximate age range 10 years to 14 years. Entrapment of cords and strings from waist and garment lower edges in moving vehicles such as bus doors, ski lifts and bicycles resulting in severe injuries or death either from being dragged or run over by a vehicle.

National legislation and voluntary agreements.

a) In 1976, the UK introduced the Children's Clothing (Hood Cords) Regulations which provided that the hood of a child's outer garment (coat or similar) must not be designed to be secured by means of a cord drawn through the material. The Regulations significantly reduced the number of fatalities through strangulation. However the garment size was defined by the chest measurement of the garment.

Changing fashion to loose fit and wadded garments allows clothing intended for children aged 5 years and upwards to fall outside the scope of the legalisation.

b) In 1998 The Consumer Agency in Finland made an agreement with Finnish importers and manufacturers to avoid import and development of children's clothing with drawstrings or cords in the hood and neck area. This concerns especially small children under 120 cm in height.

c) In 1999, the French Committee for Consumer Safety, Commission de la Sécurité des Consommateurs, introduced an experimental standard requesting manufacturers to restrict the use of cords on children's clothing. Recommendations included elimination of drawstrings and elasticated cords from the hood and neck area of garments, and restrictions on length, strength and elongation of cords and drawstrings on other areas of garments.

d) In 2000 the German Federal Ministry of Economic and Technology reached a joint voluntary agreement with German manufacturers, importers and retailers of children's clothing to refrain from producing or distributing children's clothing sizes 0 to minimum 146 with continuous tear proof cords and drawstrings in the neck area. If decorative cords or drawstrings are used they have to be non-functional and the length of these cords and drawstrings is limited to 8 cm.

e) In 2002 The Swedish Consumer Agency and the Consumer Ombudsman reached an agreement with the textile industry and retailers of Sweden, to limit the use and length of drawstrings and cords on clothing for children up to size 170 cm.

Annex B
(informative)

Anthropometric data

Anthropometric data was consulted to establish height guidance in relation to key age ranges used in this European Standard. To ensure protection of the relevant group, the 97 percentile data was used, taking into account both the tallest population of children Europe (Netherlands and Germany) and the size intervals typically used in children clothing.

For all children aged 7 years, a figure of 134 cm was selected.

For children aged 14 years, a figure of 182 cm was used for boys and 176 cm used for girls.

Table B.1 — Stature of children aged 14 years by country

Country	Source	Female mean (cm)	Female 95 percentile (cm)	Female 97 percentile (cm)	Male mean (cm)	Male 95 percentile (cm)	Male 97 percentile (cm)
Netherlands	TNO/LUMC 1997	165		178	168		184
Germany	Der Kinderarzt 1993	162,69	174,53	176,06	164,3	180	182,03
Finland	Stakes 1998	164			170		
Germany	DIN 1981	161,7	172,9		167,8	180,4	
Norway	Waler 1983	162,1			163,8		
UK	Pheasant 1988	159	170		163	178	
Hungary	Budavari 1982	157,4			162,8		
France	Joubert 1982	156			162		
Belgium	Ostyn 1980				158,4		174,2

EN 14682:2007 (E)**Table B.2 — Stature of children aged 7 years by country**

Country	Source	Female mean (cm)	Female 95 percentile (cm)	Female 97 percentile (cm)	Male mean (cm)	Male 95 percentile (cm)	Male 97 percentile (cm)
Netherlands	Steenbekkers 1993	128,6		139,7	128,7		137,7
Germany	DIN 33402 1986	128,00	137,6		128,00	137,60	
Finland	Sihvola 2000	126			127		
France	Joubert 1982	126			126		
Germany	Der Kinderarzt 1993	123,62	133,55	134,84	124,50	133,95	135,18
Norway	Waler 1983	123,2			124,3		
UK	Pheasant 1988	122	131,50		123	132	
Hungary	Budavari 1982	120,4			121,9		

Annex C **(informative)**

Rationale

In excluding garments from the scope of this European Standard consideration was given to detailed available data.

Neckties are a common form of school uniform in many countries in the EU and also are accepted as formal dress. In the majority of cases children are supervised.

Celebratory clothing such as that worn at civil or religious ceremonies, national or regional festivals is in all cases worn for limited periods and under supervision.

Specialist sportswear and activity wear, for example rugby shorts, wet suits, theatrical costumes and dancewear, is in all cases worn for limited periods and under supervision. Restrictions on cord and drawstrings may significantly reduce the functionality of the garments and/or introduce different hazards.

EN 14682:2007 (E)

Annex D (normative)

Measurement of cord length

All measurements shall be made with cords or loops in a relaxed state

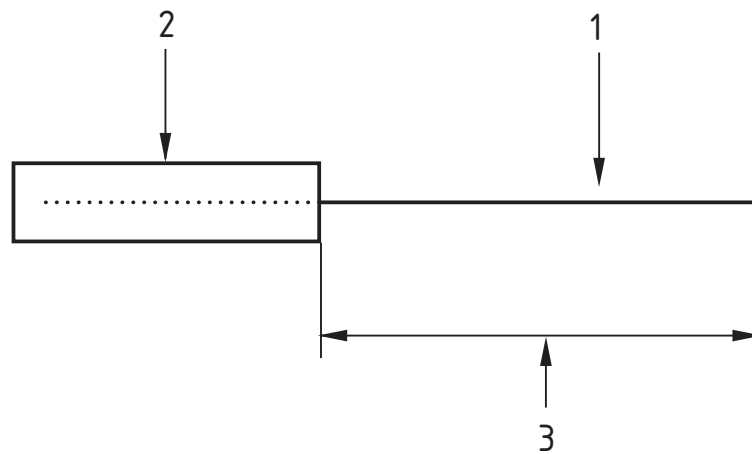

Key

- 1 cord - straight, one free end
- 2 garment
- 3 length of cord (in mm)

Figure D.1 — Measurement of cords with one free end

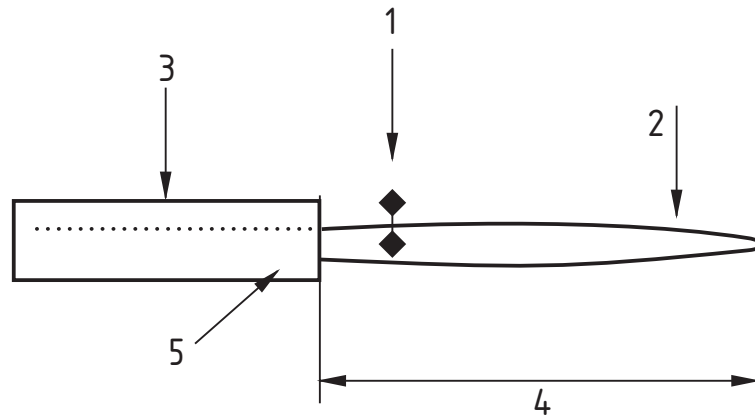

Key

- 1 toggle
- 2 cord - no free end
- 3 garment
- 4 length of loop (in mm)
- 5 fixed ends both secured inside garment

NOTE The loop circumference is twice the flat length.

Figure D.2 — Measurement of cord with no free ends

EN 14682:2007 (E)

Annex E **(informative)**

Considerations for risk assessments

The risk assessment is in relation to the aim of this European Standard which is related to the introduction: to minimise the risk of accidental entrapment in moving vehicles or strangulation by cords and strings on children's clothing.

- Decorative design features, e.g. bows, half belts, tabs, straps etc. are all features that shall be subjected to a risk assessment to establish that they do not present a hazard to the wearer of the garment.
- Functional loops used on the inside of garments for display and hanging purposes shall be subjected to a risk assessment to establish that they do not present a hazard to the wearer of the garment.

NOTE Other hazards from clothing will require separate consideration.

Annex F (informative)

Examples of cords and drawstrings

General key for all Figures in this Annex:



Acceptable



Unacceptable

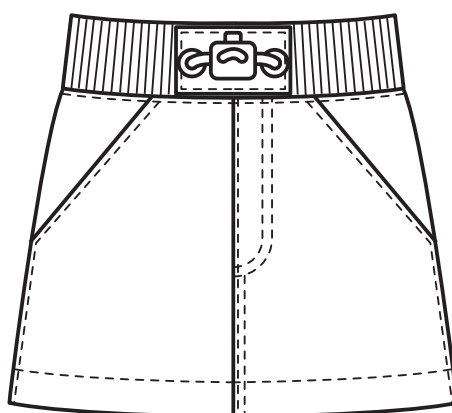

Figure F.1 — Example of drawstring with toggle with no free ends (see 3.1.2)

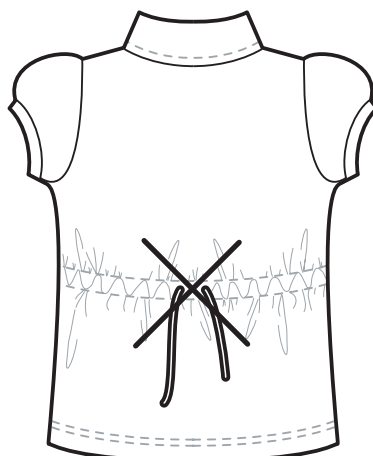

Figure F.2 — Example of back garment (see 3.6.1)

EN 14682:2007 (E)

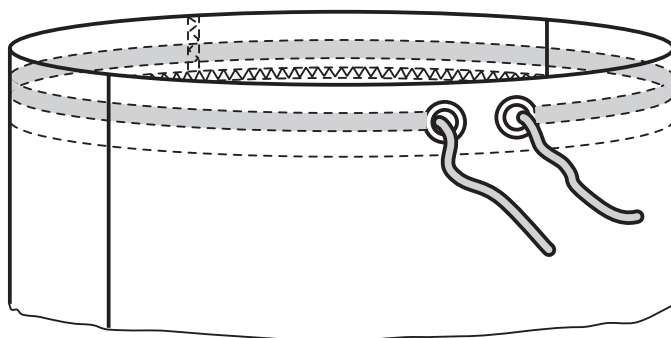

Figure F.3 — Example of drawstring with bar tacking (see 3.1.3)

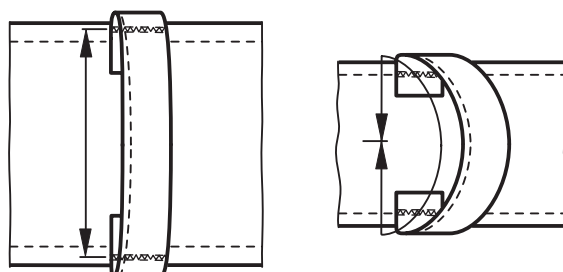

Figure F.4 — Example of belt loops (see 3.1.4)

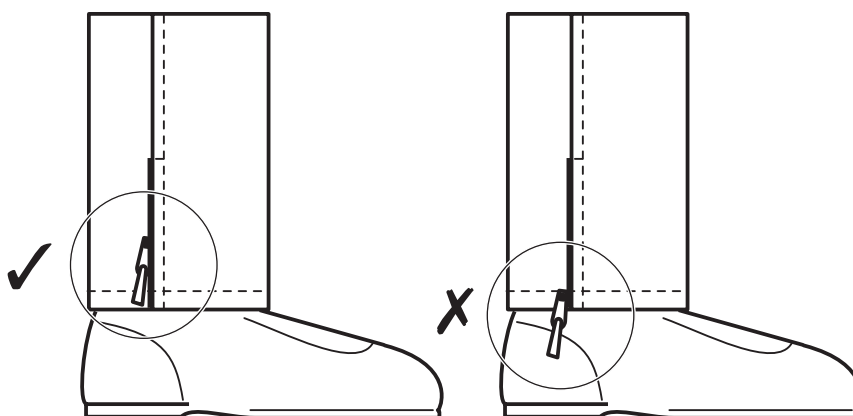

Figure F.5 — Example of permissible lower hems of garments designed to finish at the ankle (see 3.1.5)

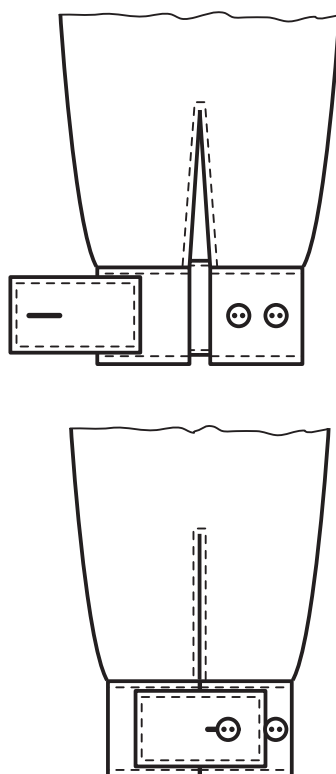
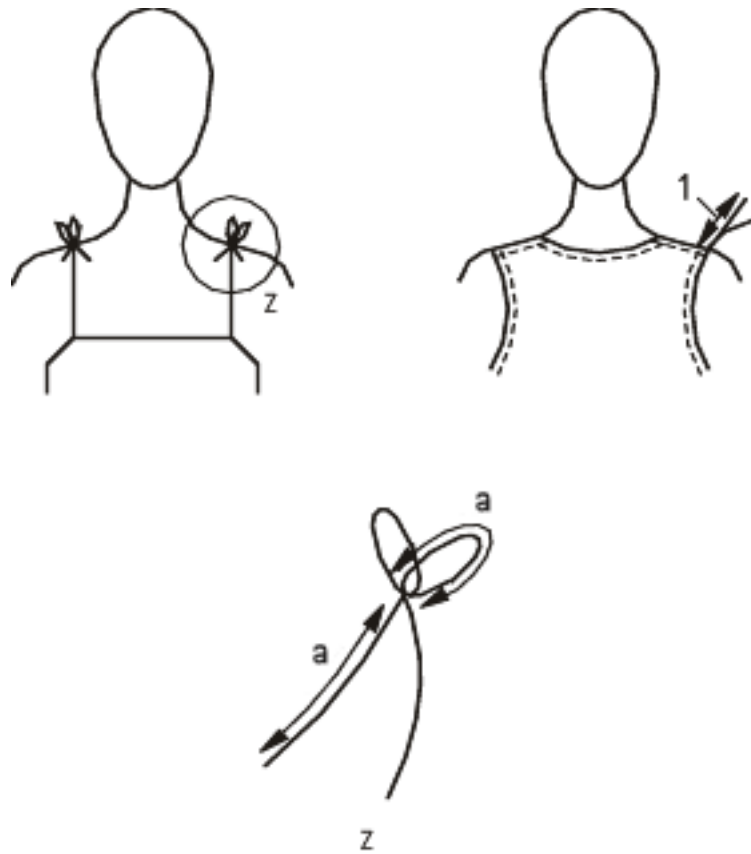

Figure F.6 — Example of adjusting tab (see 3.7.4)

EN 14682:2007 (E)



Key

1: length

For 3.2.3, length = 75 mm

For 3.3.4, length = 140 mm

a: length = 75 mm

z: detail

Figure F.7 — Example of shoulder straps with decorative cords (see 3.2.3 and 3.3.4)

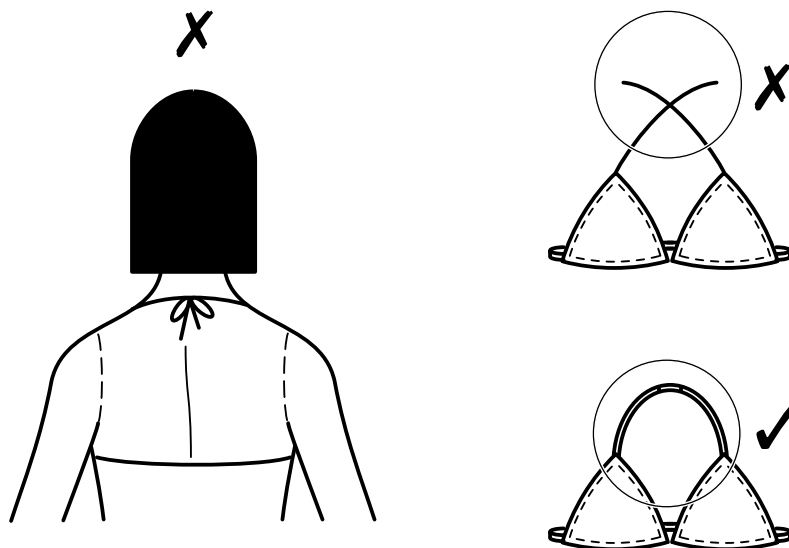

Figure F.8 — Example of halter neck with no loose ends (see 3.2.4 and 3.3.5)

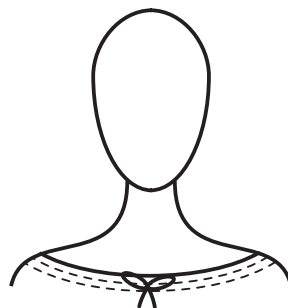
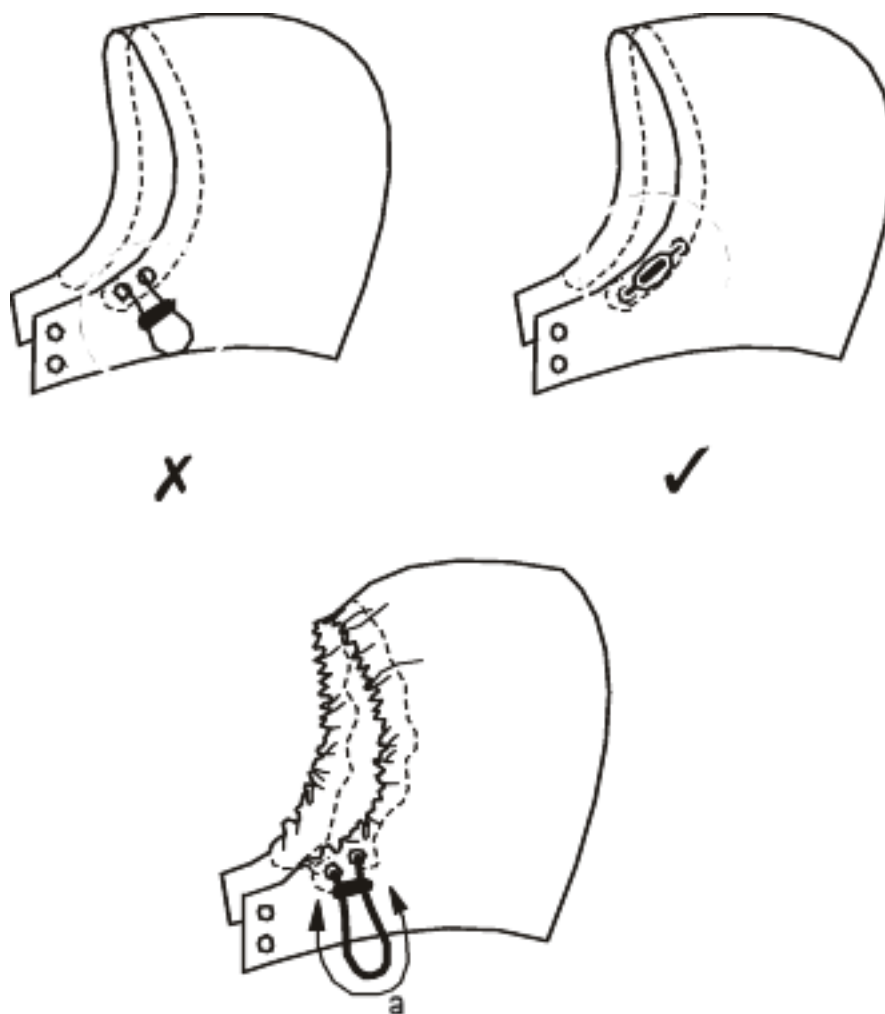

Figure F.9 — Example of permissible loop (see 3.2.5)

EN 14682:2007 (E)



Key

a 150 mm max.

Figure F.10 — Example of drawstring on hood (see 3.3.1)

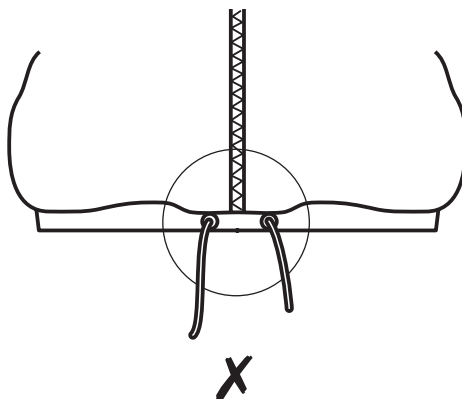

Figure F.11 — Example of unacceptable strings at lower hems of garments (see 3.5.1)

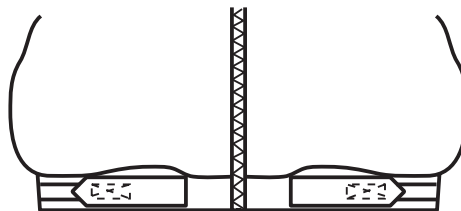

Figure F.12 — Example of adjusting tabs at lower hem (see 3.5.4)

EN 14682:2007 (E)

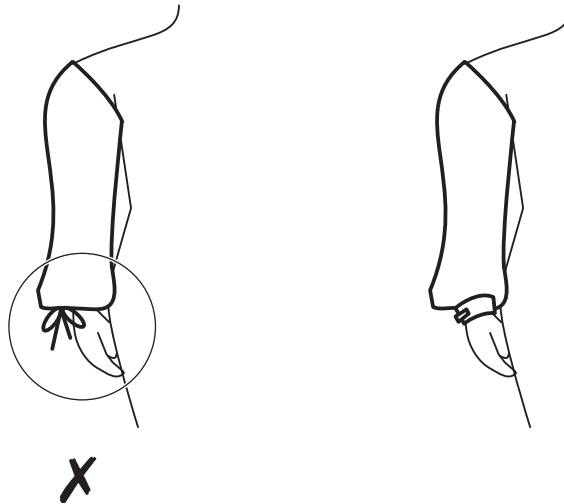
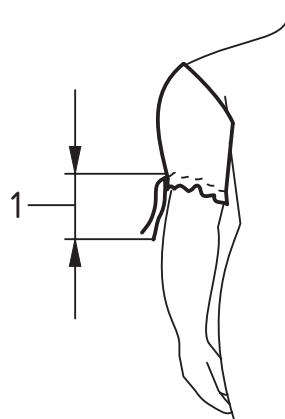

Figure F.13 — Example of long sleeves (see 3.7.1)



Key

1 = 3.7.2 young children 75 mm max.

3.7.3 older children 140 mm max.

Figure F.14 — Example of short sleeves (see 3.7.2 and 3.7.3)

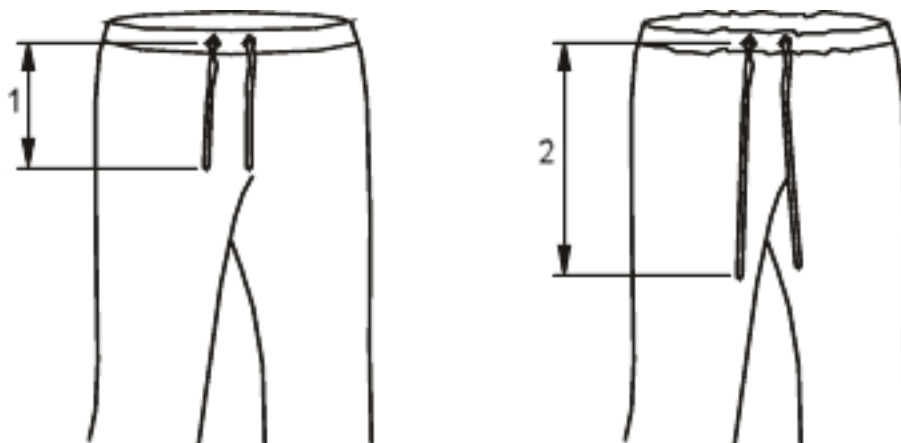

(a) Garment open to its largest

(b) Garment closed to intended waist size

Key

- 1 140 mm max.
- 2 280 mm max.

Figure F.15 — Example of waist strings (see 3.4.1)

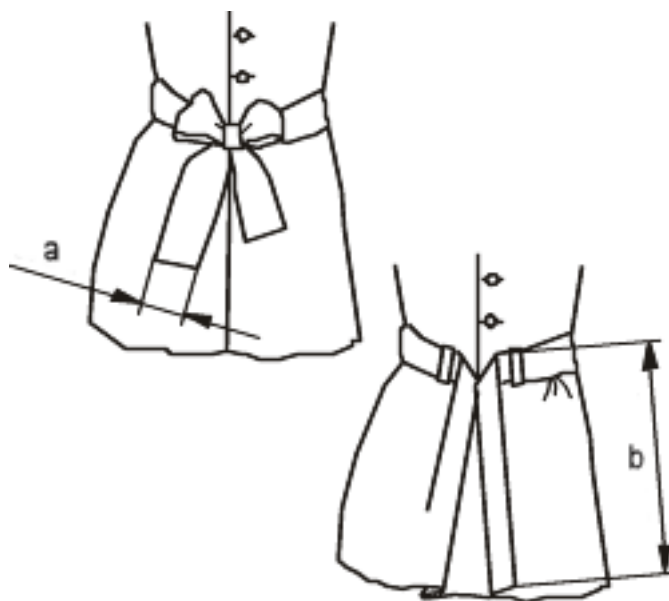

Key

- a 30 mm
- b 360 mm max.

Figure F.16 — Example of backs of garments showing permissible sashes and tie belts (see 3.4.3 and 3.4.4)

EN 14682:2007 (E)

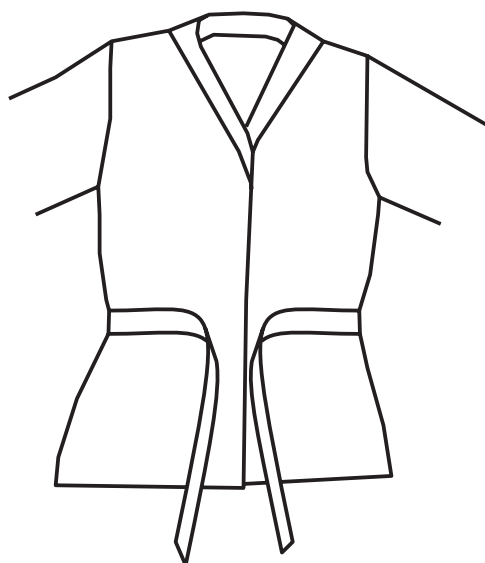

Belt width 30 mm

Belt length from where it is to tied 360 mm

Figure F.17 — Example of tied belt at front of garment (see 3.4.5)

Bibliography

- [1] ASTM F 1816-97, *Standard Safety Specification for Drawstrings on Children's Upper Outerwear*
- [2] BS 7907:1997, *Code of practice for the design and manufacture of children's clothing to promote mechanical safety*
- [3] Budavari E & Eiben O, 1982, Evaluation of school furniture with regard to students body measurements, *Ergonomia*, 15,2, 70-77
- [4] CEN/BTWG/117 N11, *Draft for comment Child safety – Guidelines for its Inclusion In standards*
- [5] CEN/TR 13387:2004, *CEN Child use and care articles – Safety guidelines*
- [6] CEN guidelines M/293
- [7] CHILDATA published by the DTI, UK, 1995
- [8] DIN 33402, *Body dimensions of people; values, June 1981*
- [9] XP G30-105 (2002) *Sécurité des vêtements d'enfants – Cordons ou Liens de serrage*
- [10] EN 71-1:2001, *Safety of toys – Part 1 Mechanical and physical properties*
- [11] Home Accident Surveillance System Annual Report. Accident Data and Safety Research: Home, Garden and Leisure UK Department of Trade and Industry Consumer Affairs and Policy Directorate
- [12] Home Accident Deaths Database; UK Department of Trade and Industry Consumer Affairs and Policy Directorate
- [13] ISO/IEC Guide 50:2002, *Safety aspects – Guidelines for child safety*
- [14] Joubert D, 1982, Le salon international de la mode enfantine, *Filière Maille*, Sept-Oct, 20
- [15] Ostyn M, Simons J, Beunen G, Renson R & Van Gerven D, 1980, *Somatic and Motor Development of Belgian Secondary Schoolboys – Norms and Standards*, Leuven University Press, Belgium
- [16] Pheasant S T 1986, *Bodyspace: Anthropometric ergonomics and design*, Taylor and Francis, London, UK.
- [17] Sihvola Seija (2000) *A Health Dialogue in the School Entrance Health Examination*, Acta Universitatis Tamperensis 751: Tampere
- [18] Stakes (1998) *Lasten ja nuorten hyvinvointi ja terveys Suomessa*, Statistical report 13/1998, 129
- [19] Steenbekkers LPA, 1993, *Child development, design implications & accident prevention*. No 1 in Physical Ergonomics Series, TU Delft (Delft University of Technology) Netherlands
- [20] UK legislation: *Childrens clothing (Hood Cords) Regulations 1976*
- [21] Waaler PE 1983, Anthropometric Studies in Norwegian children, *Acta Paediatrica Scandinavica*, Supplement 308, 2-38